

**STAINLESS STEEL AISI 304 STAMPED DISC CHECK VALVE WITH SPRING FEMALE BSP**

Stainless steel AISI 304 stamped disc check valve female BSP for chemical and pharmaceutical industries, petrochemical industries, hydraulic installation, compressed air and water.

Disc type with spring for all positions.

All stainless steel type with FKM gasket.

Short length.



**Size:** DN1/4" to DN4"

**Connection :** Female BSP

**Min Temperature :** -10°C

**Max Temperature :** +150°C

**Max Pressure :** 16 Bars

**Specifications :** Disc with spring type

All positions

Short length

**Materials :** Stainless steel AISI 304

**STAINLESS STEEL AISI 304 STAMPED DISC CHECK VALVE WITH SPRING FEMALE BSP**

**SPECIFICATIONS :**

- Stainless steel stamped check valve
- All positions (respect the flow direction indicated by the arrow)
- Short length
- Minimum backpressure for tightness : 0.5 bar up to DN1"1/2, 1 bar from DN2" to DN4"

**USE :**

- Chemical and pharmaceutical industries, petrochemical industries, hydraulic installation, compressed air
- Max Temperature Ts : - 10°C
- Min Temperature Ts :+ 150°C
- Max Pressure Ps : 16 bars

**OPENING PRESSURE ( in mbar ) :**

DN	Opening pressure (mbar)
1/4"	250
3/8"	250
1/2"	300
3/4"	350
1"	350
1"1/4	400
1"1/2	500
2"	500
2"1/2	700
3"	1000
4"	1000

**RANGE :**

- AISI 304 stamped check valve body Female / female BSP cylindrical threaded **Ref. 327** from DN1/4" to DN4"

**STAINLESS STEEL AISI 304 STAMPED DISC CHECK VALVE WITH SPRING FEMALE BSP**

**MATERIALS :**

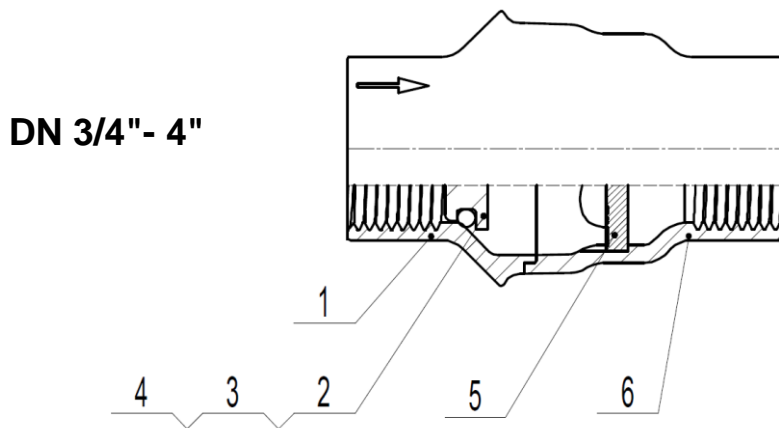
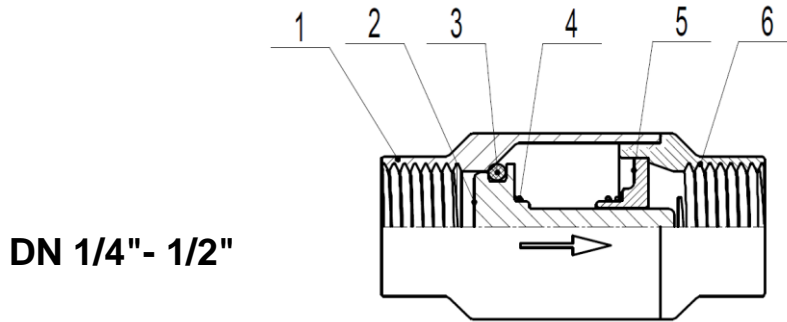

Item	Designation	Materials
1	Body	AISI 304
2	Disc	
3	Gasket	Green FPM
4	Spring	AISI 304
5-6	Seat and end	

**STAINLESS STEEL AISI 304 STAMPED DISC CHECK VALVE WITH SPRING FEMALE BSP**

SIZE DN 1/4" - 1/2" ( in mm ) :

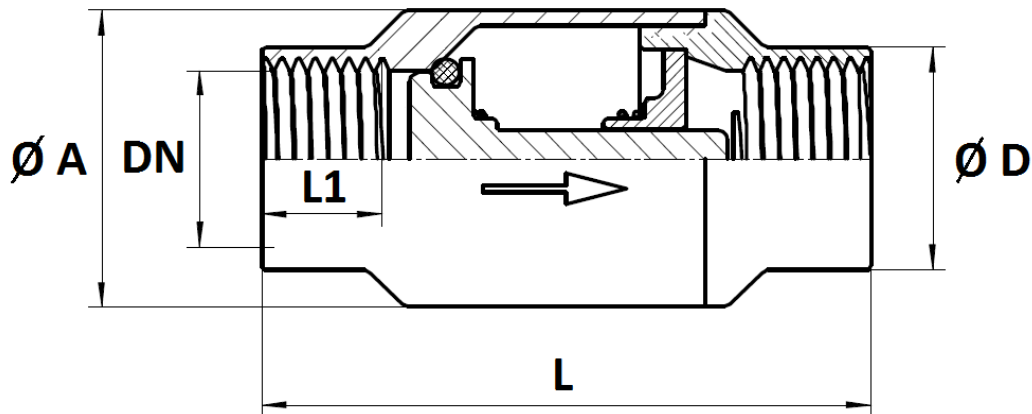

DN	1/4"	3/8"	1/2"
L	66	66	66
L1	13	13	13
Ø A	32	32	32
Ø D	18	22	24
Weight (in Kg)	0.15	0.16	0.15
Ref.	327002	327003	327004

**STAINLESS STEEL AISI 304 STAMPED DISC CHECK VALVE WITH SPRING FEMALE BSP**

**SIZE DN 3/4" - 4" ( in mm ) :**

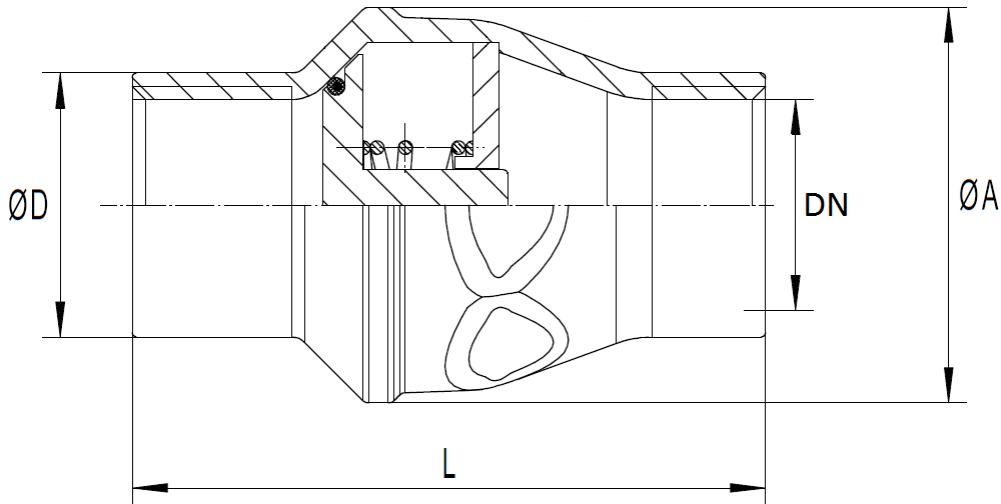

DN	3/4"	1"	1"1/4	1"1/2	2"	2"1/2	3"	4"
L	72	83	105	115	125	145	162.5	189.5
Ø A	45	55	70	76	89	109	132	168
Ø D	30	36	45.5	51	64	80	93	120
Weight (in Kg)	0.18	0.26	0.53	0.64	1.03	1.43	2.6	5.2
Ref.	327005	327006	327007	327008	327009	327010	327011	327012

**STANDARDS :**

- Manufacturer certified ISO 9001 : 2015
- DIRECTIVE 2014/68/UE : Products excluded from directive (Article 4, § 3)
- Threading BSP cylindrical according to ISO 228-1

**ADVICE :** Our opinion and our advice are not guaranteed and SFERACO shall not be liable for the consequences of damages. The customer must check the right choice of the products with the real service conditions.